



RCT6303W87 DK

10 Viking Pro

with detachable keyboard

User Manual



Need Help? Visit support.rcatablets.com

Safety Precautions



Equipment tested for compliance as a complete unit

FCC Information

This device complies with Part 15 of the FCC Rules. Operation is subject to the following two conditions: (1) This device may not cause harmful interference, and (2) this device must accept any interference received, including interference that may cause undesired operation.

This equipment has been tested and found to comply with the limits for a Class B digital device, pursuant to Part 15 of FCC Rules. These limits are designed to provide reasonable protection against harmful interference in a residential installation. This equipment generates, uses, and can radiate radio frequency energy and, if not installed and used in accordance with the instructions, may cause harmful interference to radio communications. However, there is no guarantee that interference will not occur in a particular installation. If this equipment does cause harmful interference to radio or television reception, which can be determined by turning the equipment off and on, the user is encouraged to try to correct the interference by one or more of the following measures:

- Reorient or relocate the receiving antenna.
- Increase the separation between the equipment and receiver.
- Connect the equipment into an outlet on a circuit different from that to which the receiver is connected.
- Consult the dealer or an experienced radio/TV technician for help.

Warning: Changes or modifications not expressly approved by the party responsible for compliance (MLB International Inc., PO Box 1214, Lockport, NY, 14095, Tel: 716-240-0902) could void the user's authority to operate the equipment.

CAN ICES-3(B) / NMB-3(B)

FCC Radiation Exposure Statement:

This equipment complies with FCC radiation exposure limits set forth for an uncontrolled environment. End user must follow the specific operating instructions for satisfying RF exposure compliance. This transmitter must not be co-located or operating in conjunction with any other antenna or transmitter.

The portable device is designed to meet the requirements for exposure to radio waves established by the Federal Communications Commission (USA). These requirements set a SAR limit of 1.6 W/kg averaged over one gram of tissue. The highest SAR value reported under this standard during product certification for use when properly worn on the body.

Caution: Use of controls or adjustments or performance of procedures other than those specified may result in hazardous radiation exposure.

Warning: the AC adapter is used as disconnect device and it should remain readily operable during intended use. In order to disconnect the mains plug from mains completely, the AC adapter should be disconnected from the mains socket outlet completely.

Service Information

This product should be serviced only by those specially trained in appropriate servicing techniques. For instructions on how to obtain service, refer to the warranty included in this guide.

IMPORTANT SAFETY INSTRUCTIONS

PLEASE READ AND SAVE THIS FOR FUTURE REFERENCE

Some of the following information may not apply to your particular product; however, as with any electronic product, precautions should be observed during handling and use.

- Read these instructions.
- Keep these instructions.
- Heed all warnings.
- Follow all instructions.
- Do not use this apparatus near water.
- Clean only with dry cloth.
- Do not block any ventilation openings. Install in accordance with the manufacturer's instructions.
- Do not install near any heat sources such as radiators, heat registers, stoves, or other apparatus (including amplifiers) that produce heat.
- Protect the power cord from being walked on or pinched particularly at plugs, convenience receptacles, and the point where they exit from the apparatus.
- Only use attachments / accessories specified by the manufacturer.
- Unplug this apparatus during lightning storms or when unused for long periods of time.

- Refer all servicing to qualified service personnel. Servicing is required when the apparatus has been damaged in any way, such as power-supply cord or plug is damaged, liquid has been spilled or objects have fallen into the apparatus, the apparatus has been exposed to rain or moisture, does not operate normally, or has been dropped.

ADDITIONAL SAFETY INFORMATION

- The AC adapter and apparatus shall not be exposed to dripping or splashing and no objects filled with liquids, such as vases, shall be placed on the apparatus.
- Always leave sufficient space around the product for ventilation. Do not place product in or on a bed, rug, in a bookcase or cabinet that may prevent air flow through vent openings.
- Do not place lighted candles, cigarettes, cigars, etc. on the product.
- Care should be taken so that objects do not fall into the product.
- Do not attempt to disassemble the cabinet. This product does not contain customer serviceable components.
- To prevent the risk of fire or electric shock, do not expose this apparatus to rain or moisture.
- Do not play your headset at high volume. Hearing experts warn against extended high-volume play.

Contents



Safety Precautions	1
Important Safety Instructions	4
Startup	7
Overview of Controls	7
Buttons	8
Keyboard	9
Accessory	10
Navigating the Home Screen	11
Connections	15
Battery Management and Charging	15
USB/Micro-USB	16
Headphone	17
Micro SD	17
HDMI	18
Wi-Fi	19
Bluetooth	20
Basic Operation	22
First Time Operation	22
Basic Operation	22
Google Now™	24
Voice Search & Voice Actions	24
Google Play™	25
Settings	26
Google™	28
Preinstalled Apps	28
Additional Information	29
Trouble Shooting	29
Copyright and Trademark Notices	30
Specifications	31
Limited Warranty	32

Startup

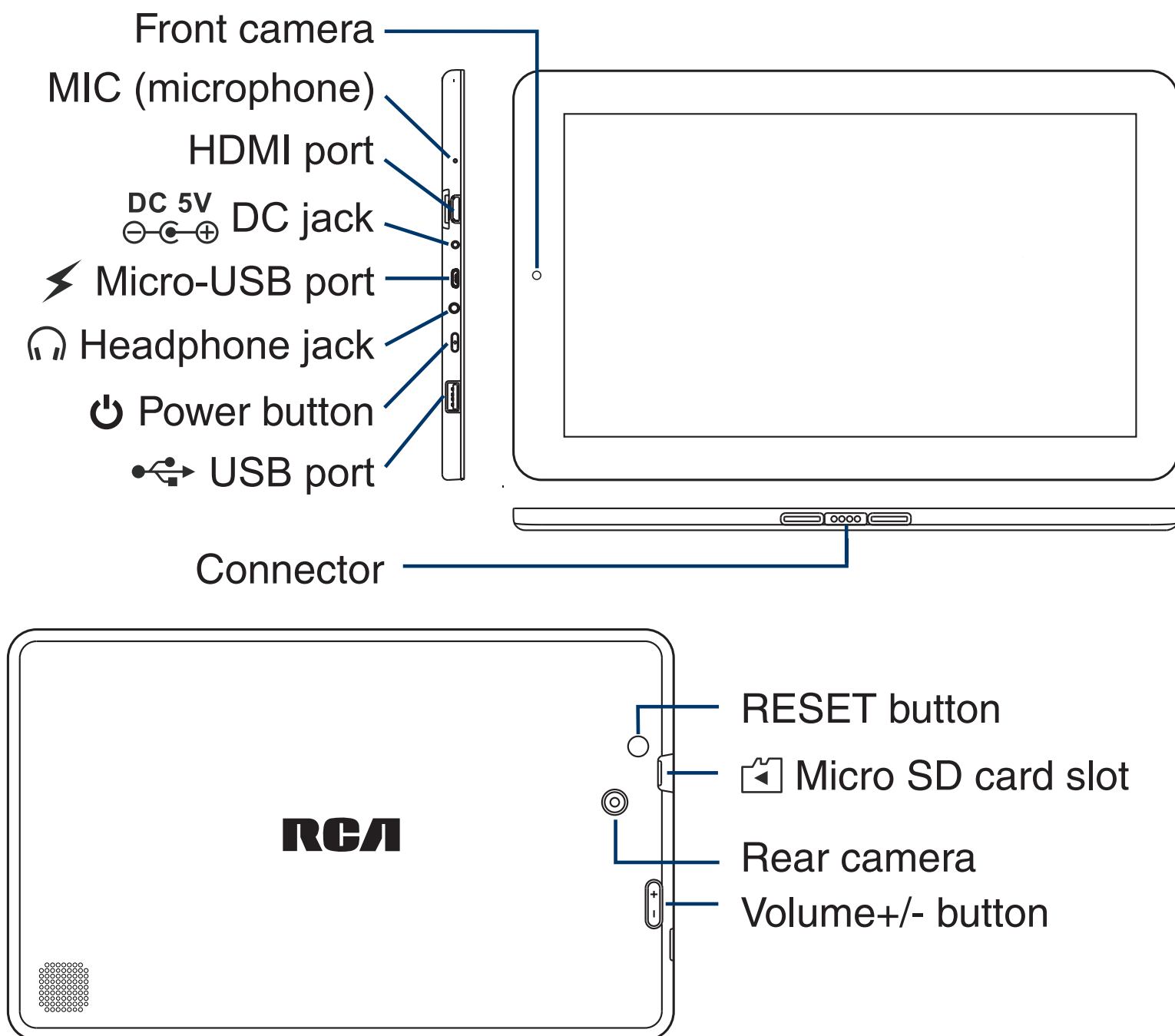
Overview of Controls



Item	Description
Microphone	For voice input.
HDMI port	Connect to a TV or a display device.
DC jack	Connect with 5V DC charger.
Micro-USB port	Use to charge the tablet's battery.
Headphone jack	Headphone connection for personal listening.

Power button 	Press to enter standby/wake up mode, press and hold to switch On/Off the unit.
USB port	Connect to a USB storage device or a mouse or a wire keyboard.
Connector	Use to connect the keyboard.
Reset	Press to reset the tablet (then press and hold the Power  button for 4~5 seconds to turn on the unit).
Micro SD card slot	Accepts micro SD card (up to 32G).
Volume +/- button	Press to increase/decrease the volume.



Buttons

Power button

Power the tablet On

Press and hold the **Power**  button until the RCA logo appears.

Power the tablet Off

Press and hold the **Power**  button until the "** Power off**" message displays, then tap it and the tablet will be powered off.

Sleep Mode

Briefly press the **Power** button to put the tablet in sleep mode. If you don't operate for some time, the tablet will enter sleep mode automatically.

Tip: You can go to **Settings -> Device -> Display -> Sleep** to set the screen timeout.

Wake the tablet from Sleep Mode

Press the **Power** button to wake the tablet from sleep mode.

Volume +/- button

Press the **Volume +/-** button to increase or decrease the volume.

Tip: You can go to **Settings -> Device -> Sound & notification -> Sound general settings** to adjust volume settings.

Keyboard

Overview

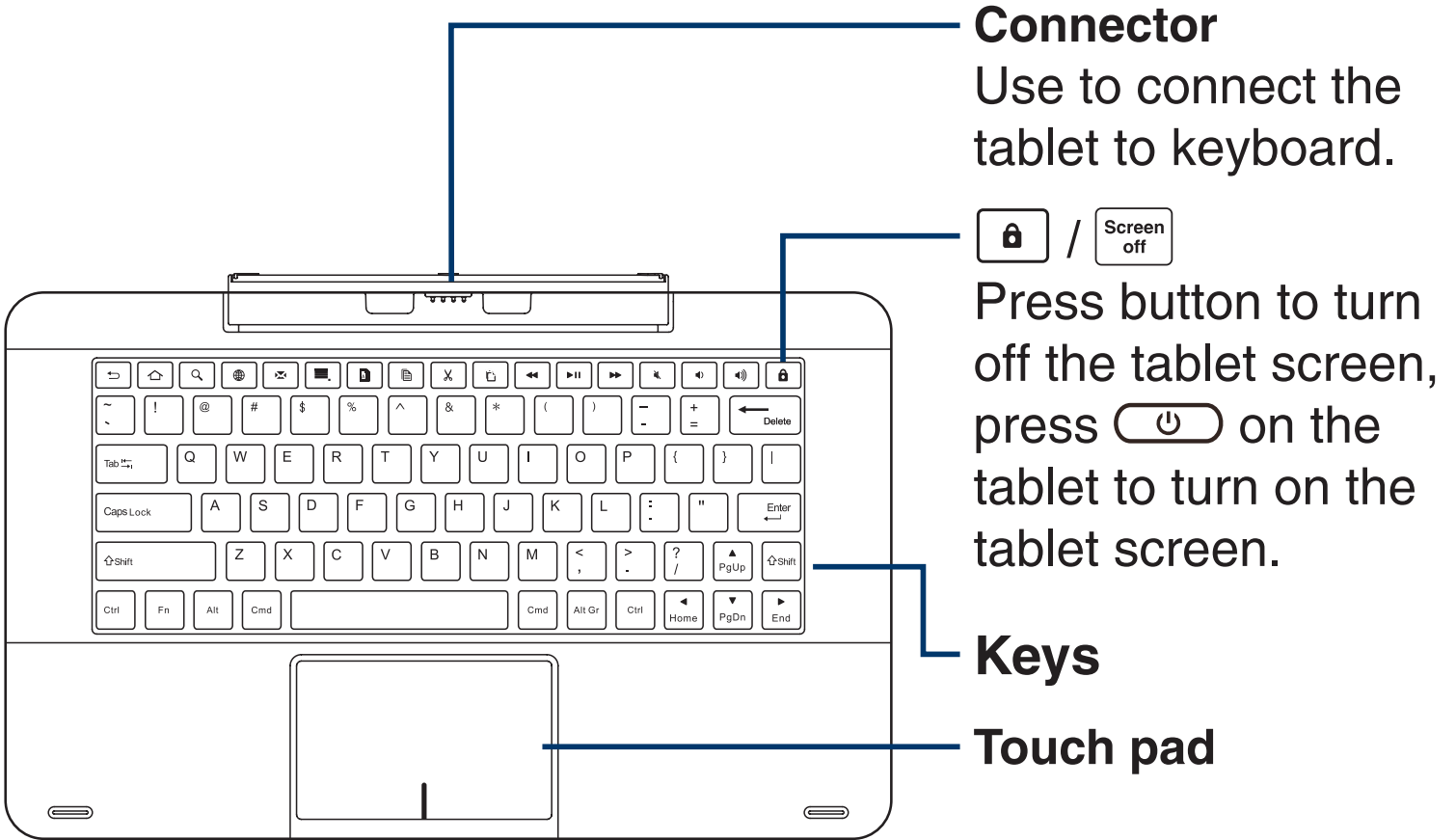

Remove tablet from keyboard

1

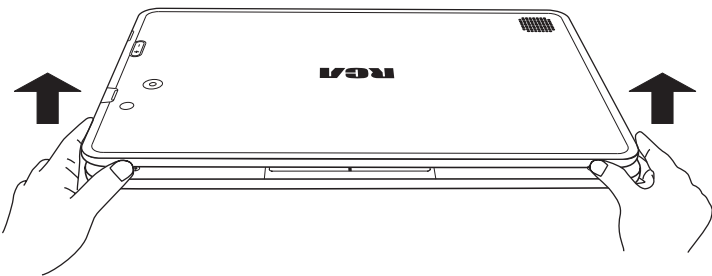

2

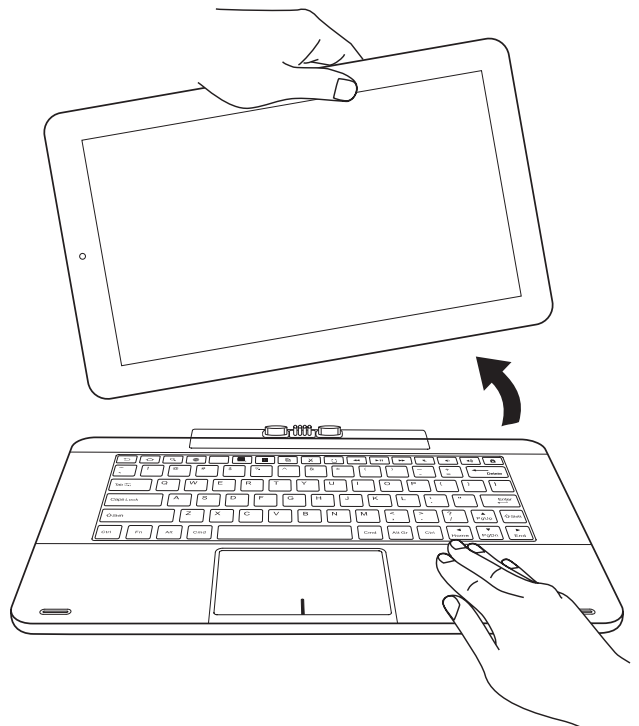

Tablet docking

There are two ways to dock the tablet onto the keyboard.

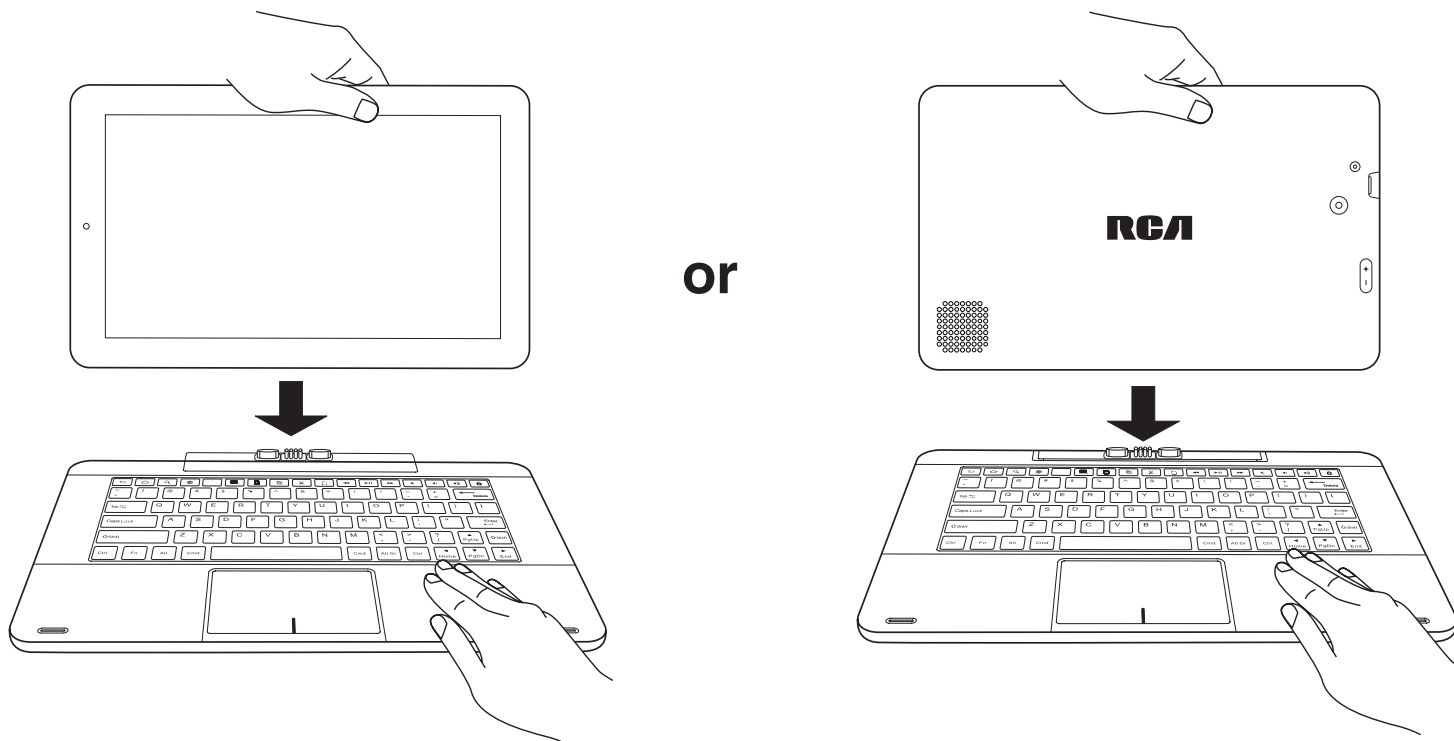

NOTE

The keyboard connects to the tablet via the Connector. When the connection is successful, the tablet will automatically adjust its settings to use the keyboard.

Accessory

The following accessory is included.

AC Adapterx1

Navigating the Home Screen

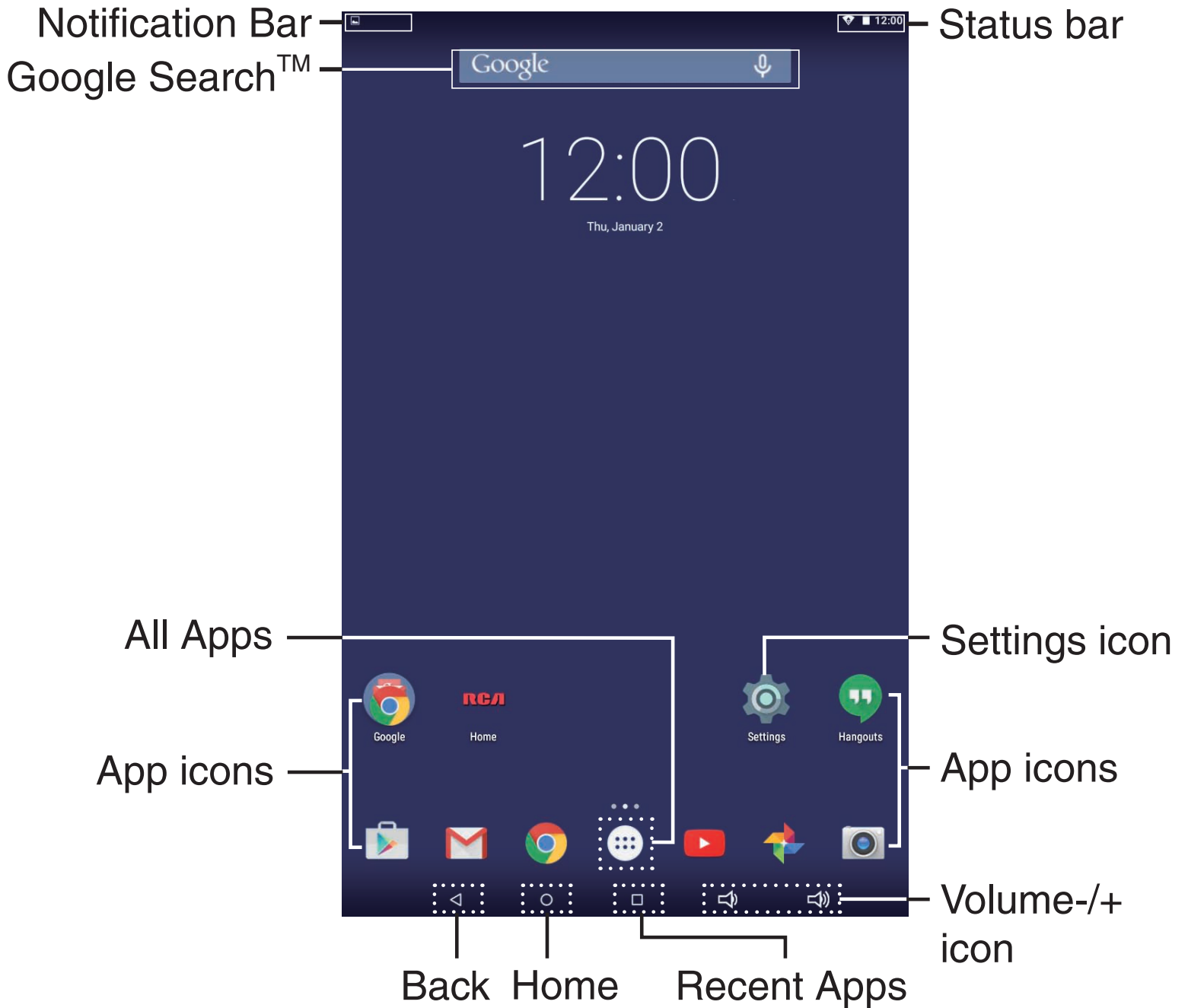

Notification & Status Bar

Some indicators that inform you about the status of your tablet are shown at the top of the screen.

Notification Shade

Notifications may come from the system, a game, an application such as E-mail, or the music player.

When Notifications are available, related icons will appear in the top left corner of the screen. To open the Notification Shade, touch the Notification icon and swipe your finger down. Some notifications allow you to take specific actions by tapping icons within the notification.





After you are finished with a notification, just slide it away to the left or right. If you want to dismiss all notifications, tap the Dismiss icon  at the top of the notification.

Status Bar & Quick Settings

The Status Bar in the top right corner shows various indicators, including Wi-Fi connection and battery status. To access "Quick Settings", touch the status bar and swipe down. You can then adjust various settings on the tablet by touching the corresponding square.

Notification & Status Icons

The below table lists some of the frequently used icons in the Notification & Status bar:



Item	Description
 Message	Received new message.
 Music	The Google Play Music app is running.
 Wi-Fi	Has a Wi-Fi Internet connection.
 Bluetooth	Bluetooth is on.
 Play Store	An update for an app is available.

Home Screen Icons

All Apps

Tap the All Apps icon  to enter the All Apps screen.

In All Apps screen, you can:

- Move between screens: Slide left or right.
- Open an App: Tap its icon.
- Copy an App icon to the Home screen: Press and hold the icon or widget icon slowly to drag it to the Home screen.
- Get more apps: Tap the Google Play Store icon .
- View info about an App: Press and hold it, and drag it to the top of the screen, then drop the app over the App Info icon .

Tip: Most apps include a Menu icon  near the top or bottom of the screen that lets you control the app's settings.

Back

Tap Back icon  to return to the previous screen.

- The Back icon remains on the bottom of the screen at all times, allowing you to navigate back to the previous screen.
- Once you go back to the Home screen, you can't go back any further in your history.

Home

Tap Home icon  from anywhere on your tablet to return to the Home screen.

Recent Apps

Tap Recent Apps icon  to view recently used apps. Tap an app to use it again.

You can slide down to see more apps. You can also slide it away to the left or right.

Volume &

Tap Volume icon  to increase volume.

Tap Volume icon  to decrease volume.

Connections

Battery Management and Charging

The tablet has a built-in rechargeable battery.

Battery Icon

The battery icon in the upper-right corner shows the battery level or charging status.



Full battery



Low battery



Need to be charged



Charging

Charging the Battery

Use the AC Adapter or the Micro-USB port to charge the battery.

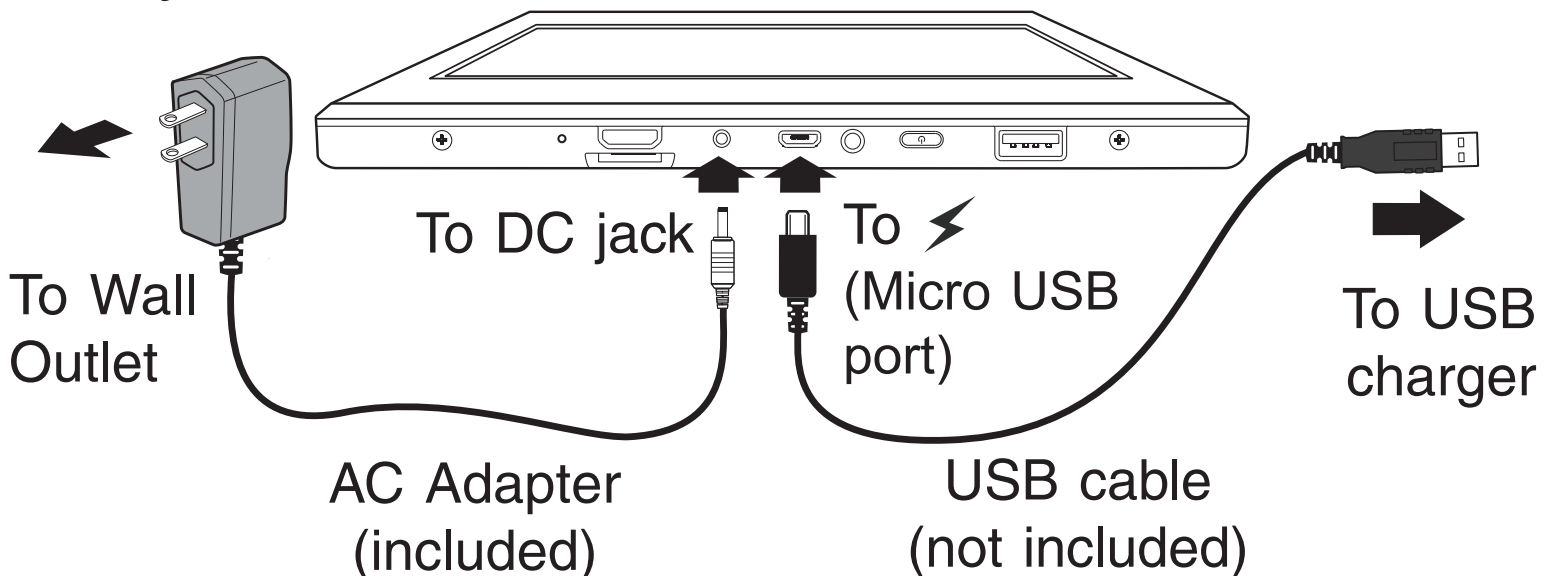

Note: In order to keep the battery working in best condition, please pay attention to the following:

- The included AC adapter is for use with this unit only. Do not use it with other equipment.
- Please do not charge the battery in high temperatures.

- Do not wait for the battery to be fully depleted before charging again. Keep the battery charged as needed.
- If tablet has not been used for a long period of time, the battery might be in over discharge protection mode and may take longer to charge.

Prolong the Battery Life

Here are some tips for how to prolong the life of the battery:

- If you aren't using Wi-Fi, go to **Settings -> Wireless & networks -> Wi-Fi**, turn it off.
- Don't leave the Maps or Navigation apps open on the screen when you're not using them.
- Turn down screen brightness and set a shorter screen timeout: **Settings -> Device -> Display**.
- If you don't need it, turn off automatic syncing for all apps: **Settings -> Personal -> Accounts -> [Google account-name]**. This means you need to sync manually to collect messages, email, and other recent information, and won't receive notifications when updates occur.

USB

The tablet can be connected to an USB storage device to transfer music, pictures and other files in both directions.

Headphones

Headphones can be connected to the tablet's Headphone jack.

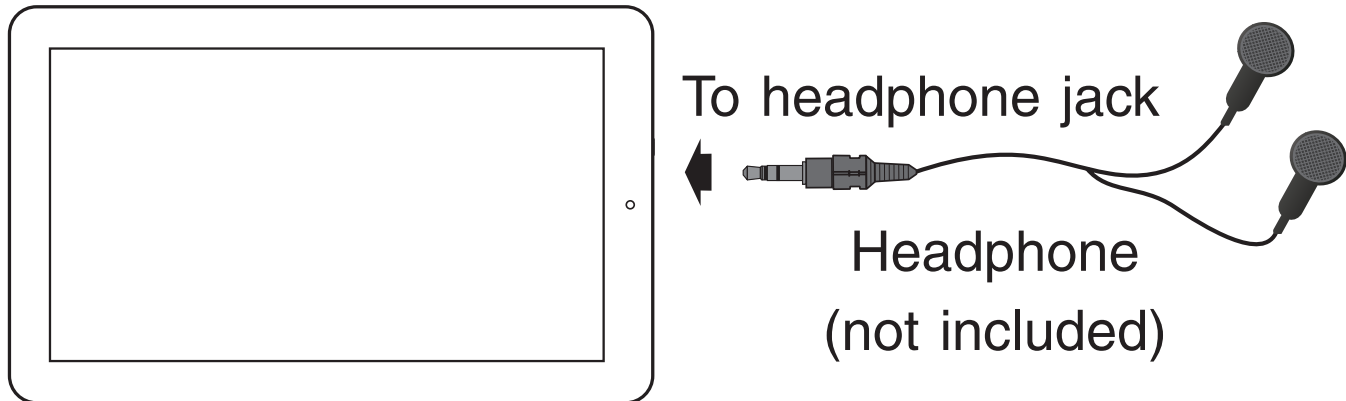

Micro SD

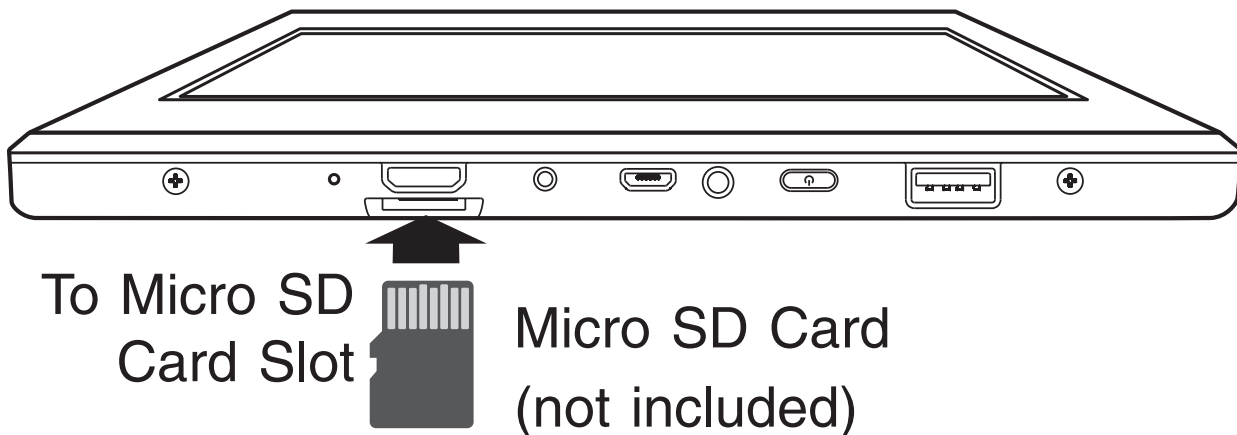

Insert the micro SD card into the tablet's Micro SD slot until it clicks.

To check the storage of the micro SD card, go to **Settings** -> **Device** -> **Storage**.

Remove the micro SD card by pushing in on the card's edge. The card will pop out and can be removed.

Notes:

- You can use micro SD™ card and micro SDHC™ card (up to 32GB, SD card not included).
- Never remove or insert micro SD card in On mode.

HDMI

You can connect the unit to a TV or other display device using an HDMI cable through the HDMI port.

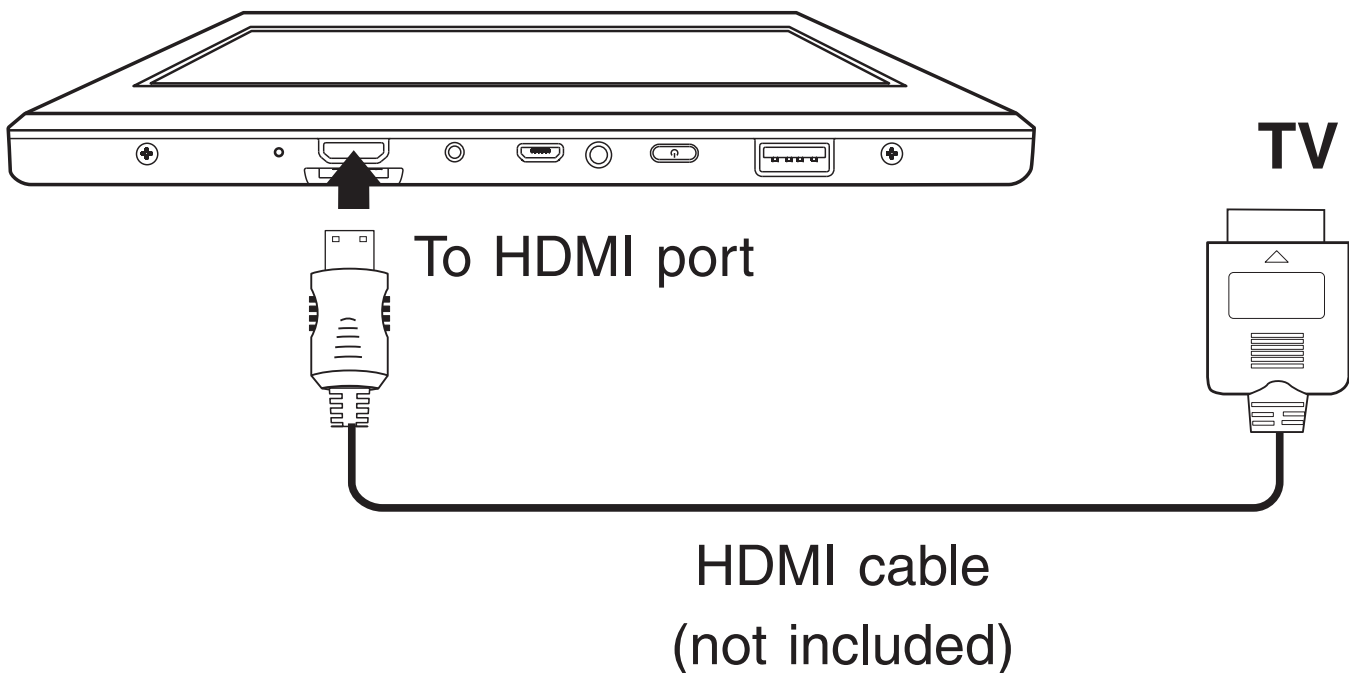



1. Go to **Settings -> Device -> Display -> HDMI settings**, to turn on the HDMI.
2. The system interface on the unit is automatically synchronized with your TV screen.

Wi-Fi

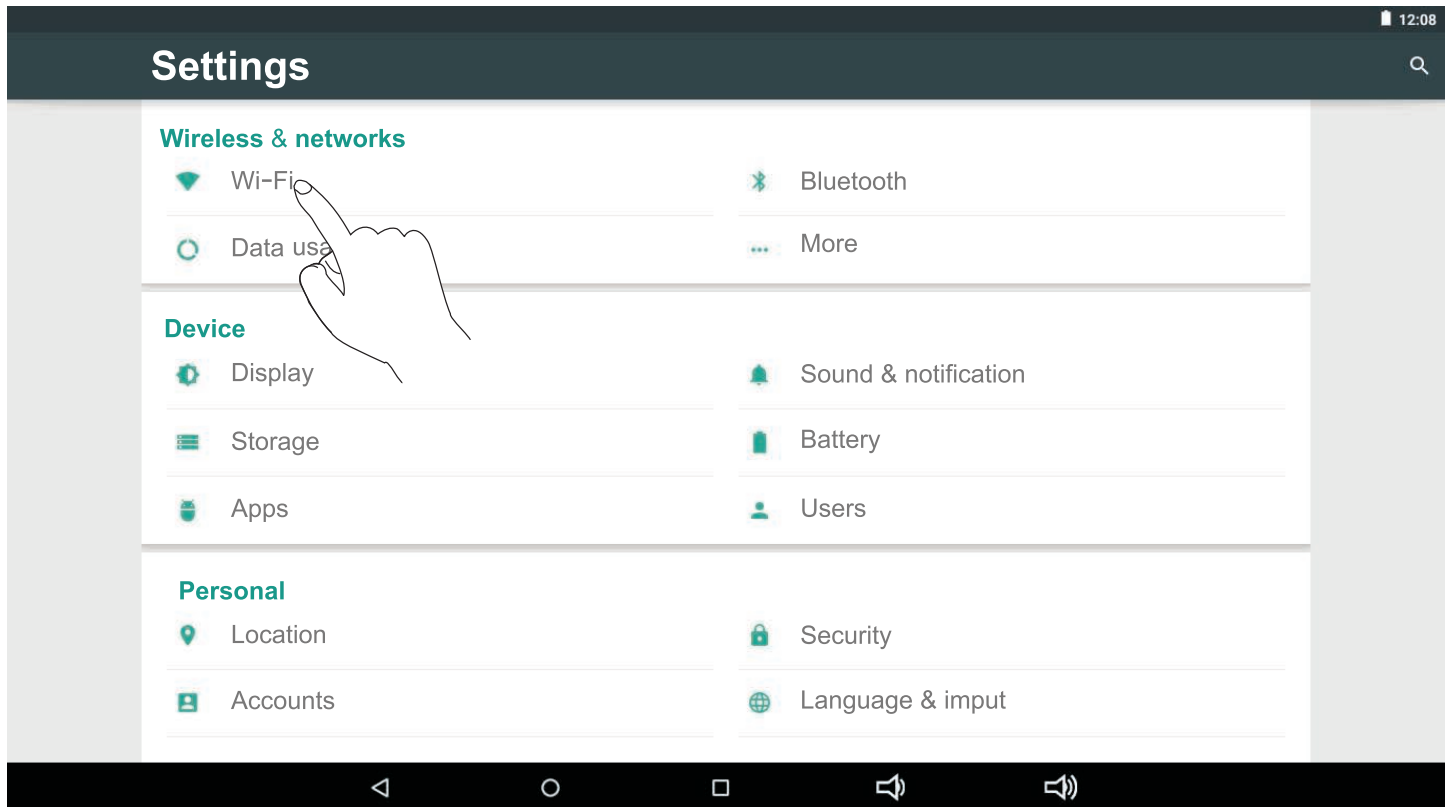
Connect to a Wi-Fi Network



1. Go to **Settings** -> **Wireless & networks**, tap **Wi-Fi** to open the Wi-Fi screen and slide **Wi-Fi** to the **ON** position.
2. The device will scan Wi-Fi networks automatically and display the available names.
 - **If the device finds a network that you connected to previously, it will connect to it automatically.**
3. Tap a network name to connect to it, and enter a password if necessary.
4. Alternatively, if your Wi-Fi router supports Wi-Fi Protected Setup, you can go to the Advanced Wi-Fi screen (tap **Menu icon**  at the upper right corner and select **Advanced**) and select **WPS Push Button**, then press the WPS button on your router.

5. If your network does not broadcast its SSID, tap **Menu icon**  at the upper right corner and select **Add network**, and enter the Network SSID (name) of the network. If necessary, enter security or other network configuration details.

Note: you can tap **Menu icon**  at the upper right corner in the **Settings** screen for advanced settings.

VPN (Virtual Private Network)

You can create virtual private network (VPN) and connect to your private network securely through a public network, such as the internet. You must set a lock screen PIN or password before you can use credential storage.

Add VPN network and follow the instructions on the screen.

Bluetooth

You can use Bluetooth to communicate between the unit and other Bluetooth devices, such as a smartphone.

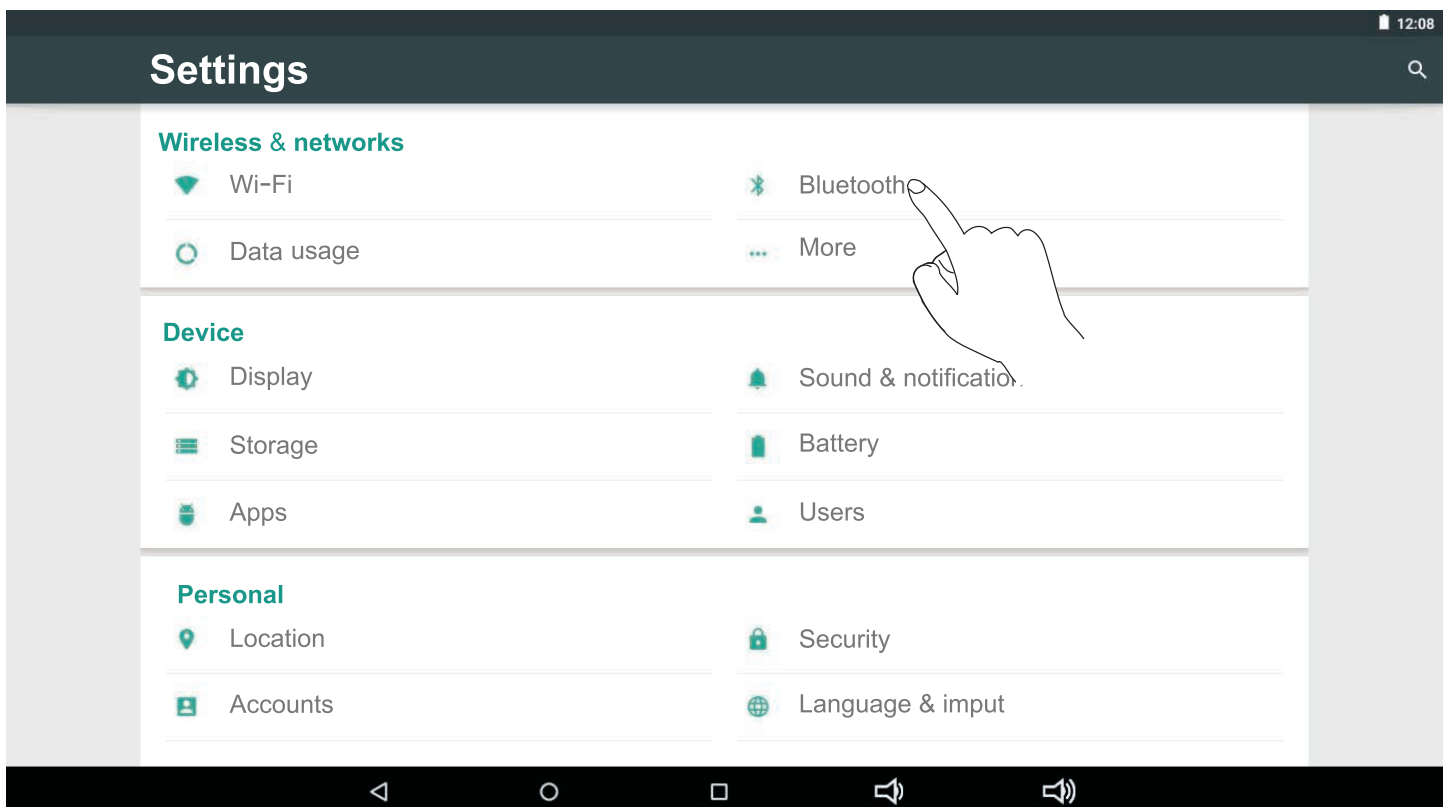



1. Go to **Settings** -> **Wireless & networks**, tap **Bluetooth** to open the Bluetooth screen and slide **Bluetooth** to the **ON** position.
2. It will scan automatically and display the available bluetooth devices.
3. Tap an available bluetooth device name to pair with it and follow the instructions to complete the pairing.

Note: You can tap **Menu icon**  at the upper right corner and select **Refresh** for scanning again.

Receive Files

When the Bluetooth share icon  is shown in the Notification bar, touch and drag it to open the Notification Shade. Tap the notification and follow the instructions to complete the receiving.

Send Files

1. Go to **All Apps**  -> **File Manager**.
2. Select a file you want to send, touch & hold it until the Notification bar appears. Touch icon  and select **Bluetooth**, then follow the instructions to complete the sending.

Basic Operation

First Time Operation

Turning Your Tablet On for the First Time

When using the tablet for the first time, you will be required to setup the following:

1. Select the language, then tap .
2. Set the Wi-Fi.
3. If you have a Google Account, select "Yes". Then tap a network name to see more details or connect to it, and enter a password if necessary.

When prompted, sign in using the email address and password for your Google Account. If you don't have one yet, go ahead and create one.

4. Follow the onscreen instructions to setup the tablet.

Basic Operation

Using the Touchscreen

Here are some basic procedures for interacting with the touchscreen.

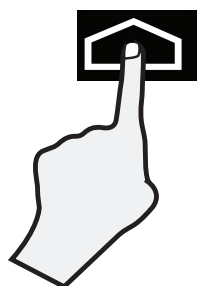

Tap

To select an item on the touchscreen, lightly tap it.

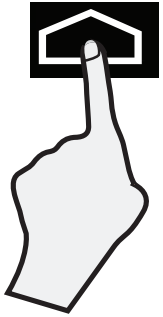

Press & Hold

In some instances, touching the item and holding your finger on it will present other options or menus.

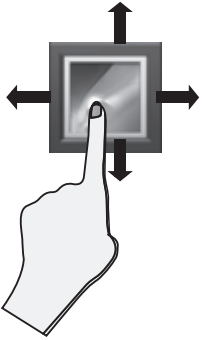

Drag or Swipe

While holding an item such as an icon, it can sometimes be moved by dragging it to another area or screen. You may also be able to swipe your finger across a screen or item to navigate or move it.

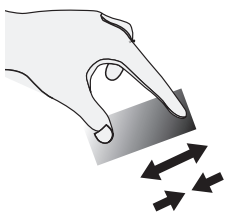

Zoom

By placing two fingers on the screen, you can slide them apart to "Zoom In", or pinch them together to "Zoom Out".

Customizing the Home Screen

- From All Apps screen to Home screen: Tap All Apps icon (⋮) to open All Apps screen, press & hold an icon slowly to drag it to the location of your choice. This makes it much easier to change your Home screen layout.
- View widgets: Press & hold the screen on your Home screen, the widgets icon will display, and then tap it. Widgets are app information displays that can be placed on your Home screen.

- Move apps or widgets: Press & hold an icon or widget, slowly to drag it to the screen edge, the screen will switch.
- Delete apps or widgets: Press & hold an icon or widget, when the "X" icon appears at the top of the screen, drag the icon or widget into it.
- Press & hold the screen on your Home screen, and the wallpaper icon will display, tap it and choose a wallpaper.

Google Now

To create a truly personalized experience, using your location and personal Google account information, use Google Now. Touch and Hold the Home icon, and slide up to the Google Now icon. Follow the instructions to setup your Google Now experience.

Voice Search & Voice Actions

Turn Voice Search or Voice Action On

You can initiate a Voice Search or Voice Action by tapping the Microphone icon on top of the Home screen.

When you're viewing the Google Now screen, you don't have to touch anything. Just say "Google."

Note: To detect when you say "Google" to launch Voice Search or Voice Actions, your tablet analyzes sound picked up by your tablet's microphone in intervals of a few seconds or less.

Using Voice Search

After tapping the microphone icon, just say whatever it is you want Google to search for.

Using Voice Actions

There are many actions that the tablet can perform using "Voice Actions". For example, you can send emails, set alarms, play a song, or navigate to a website. Just tap the Microphone icon, and say what you want the tablet to do. As you speak, Voice Search analyzes your speech and initiates the action.

If Voice Search doesn't understand you, it lists a set of possible meanings. Just tap the one you want.

Google Play

In addition to the apps that come preinstalled on your tablet, you can download Android apps and games, music, movies, TV shows and magazines using the Google Play Store app.

1. On the App menu, touch the Google Play Store icon.
2. To search for an item from the Google Play Store app, touch the search icon in the upper right corner, and then type a keyword to search.
3. Touch an available item to go to its details page. From there you can install or download the item.

Settings

Settings lets you configure the tablet, set app options, add accounts, and change other preferences.

Wireless & networks

Wi-Fi — Enable or disable **Wi-Fi**, and connect to a wireless network so that you can check email, search the Web, or access social media websites.

Bluetooth — Enable or disable **Bluetooth**.

More... — Enable or disable **Airplane mode** or **VPN**.

Device

Display — Set **Wallpaper**, **Brightness level**, **Sleep**, **Daydream**, **Font size**, **HDMI settings**, **ScreenshotSetting**, **when device is rotated** and **Cast screen**.

Sound & notifications — Set **Sound general settings**, **Notification & Others**.

Storage — View available space in **Internal Storage**, **USB Storage** and **SD Card** /set the related items.

Battery — View battery status.

Apps — View downloaded apps and running apps. To view information or uninstall an app, tap the relevant app.

Personal

Location — Set **Mode**, **Recent location requests** and **Location services**.

Security — Set preferences for **Screen security**, **Passwords**, **Device administration**, **Credential storage** and **Advanced**.

Language & input — Set preferences for **Language**, **Keyboard & input methods**, **Speech** and **Mouse/trackpad**.

Accounts — You can add an email account or another type of account.

Backup & reset — Set preferences for **Backup & restore**, and **Personal data**.

SYSTEM

Date & time — Enable or disable **Automatic date & time**, and select preferences for date, time, time zone, time format, and date format.

Accessibility — Select preferences for **Services**, **System** and **Display**.

Printing — Enable or disable **PRINT SERVICES**.

About tablet

Check System updates, Status, Legal information, User Manual, etc.

Google

A Google Account lets you organize and access your personal information from any computer or mobile device.

Add an Account

You can use multiple Google Accounts and Microsoft Exchange ActiveSync accounts on your tablet.

You may also be able to add other kinds of accounts, depending on your apps. To add some accounts, you may need to obtain details from your system administrator about the service to which the account connects. For example, you may need to know the account's domain or server address.

1. Go to **Settings** -> **Personal** -> **Accounts** -> **Add account**.
2. Tap the kind of account to add. And then follow the on-screen instructions.

Remove an Account

To remove a Google account, go to **Settings** -> **Personal** -> **Accounts** -> **Google** -> [account-name] **Menu icon** -> **Remove account**.

Preinstalled Apps

Your tablet comes with many apps preinstalled to allow you to browse the web, send and receive email, and access entertainment. Spend some time exploring these apps to learn how your tablet can be most useful for you.

Additional Information

Trouble Shooting

Tablet displays network or service error message

- When you are located in places with poor signals, your tablet may lose its Wi-Fi connection. Try moving closer to the Wi-Fi router.

Touch screen response is slow or incorrect

If the tablet's touch screen response is incorrect, please try the following:

- Remove any protective film of the touch screen. The protective film may prevent the device recognition input.
- Make sure that your fingers dry and clean before you tap the touch screen.
- Restart the tablet to clear any temporary software bugs.

Tablet is frozen or a serious error appears

- If the tablet is frozen or suspended, you may need to close the app program or reset the tablet.
- If the tablet is frozen or slow to respond, press and hold the power button for 8 seconds to reset the tablet.
- If that doesn't work, press the RESET button at the back of the tablet; then press and hold the **Power**  button for 4~5 seconds to turn on the unit.

Tablet gets warm

- When using for a long time, the tablet may be warm. This is normal and will not affect the life or performance of the unit.

Tablet can not show video of opposite side during skype call

- The Wi-Fi signal is poor. Please move close to your wireless router, or disconnect other devices from your wireless

- router, or increase bandwidth of internet connection.
- Please check the Wi-Fi setting. It's recommended to use an IEEE 802.11 b/g/n. certified Wi-Fi network.

Copyright and Trademark Notices

Android, Google, Google Play and other marks are trademarks of Google Inc.

The Wi-Fi CERTIFIED Logo is a certification mark of the Wi-Fi Alliance.

The Wi-Fi Protected Setup Mark is a mark of the Wi-Fi Alliance

The *Bluetooth*[®] word mark and logos are registered trademarks owned by the *Bluetooth* SIG Inc. Other trademarks and trade names are those of their respective owners.



The terms HDMI and HDMI High-Definition Multimedia Interface, and the HDMI Logo are trademarks or registered trademarks of HDMI Licensing LLC in the United States and other countries.

About HDMI

High-Definition Multimedia Interface (HDMI) is a high-speed digital interface that can transmit uncompressed high definition video and digital multichannel audio. It delivers high quality picture and sound quality. HDMI is fully backward compatible with DVI. As required by the HDMI standard, connecting to HDMI or DVI products without HDCP (High bandwidth Digital Content Protection) will result in no Video or Audio output.

Specifications

Power: DC IN 5V (operate with AC adapter)

Front Camera: 2.0 Megapixel

Rear Camera: 2.0 Megapixel

Specifications and external appearance are subject to change without notice.

Limited Warranty

AVC MULTIMEDIA (“AVC”) makes the following limited warranty. This limited warranty extend to the original consumer purchaser and is limited to non-commercial use of the product.

One Year Parts & Labor Warranty

AVC products purchased in the United States or Canada are warranted to be free from defects in materials or workmanship for a period of one year from the date of their original retail purchase. If the unit fails to conform to this warranty, we will service the product using new or refurbished parts and products, at **AVC’s** sole discretion.

During a period of one year from the effective warranty date, **AVC** will provide, when needed, service labor to repair a manufacturing defect at its designated Service Center. To obtain warranty service in the United States or Canada, you must first contact our Customer Support Center at **support.rcatablets.com**. The determination of service will be made by **AVC** Customer Support. **PLEASE DO NOT RETURN YOUR UNIT TO AVC WITHOUT PRIOR AUTHORIZATION.** New or remanufactured replacements for defective parts or products will be used for repairs by **AVC** at its designated Service Center for one year from the effective warranty date. Such replacement parts or products are warranted for an additional one year from the date of repair or replacement. The Customer will be required to ship the unit to the Service Center indicated at the time Customer Support is contacted to make the necessary repairs. The customer is responsible for all transportation charges to the service facility.

Packaging and Shipping Instruction

When you send the product to the **AVC** service facility you must use the original carton box and packing material or an equivalent as designated by **AVC**.

Your Responsibility

- (1) You must retain the original sale receipt to provide proof of purchase.
- (2) These warranties are effective only if the product is purchased and operated in the United States or Canada.
- (3) Warranties extend only to defects in material or workmanship, and do not extend to any product or parts which have been lost or discarded, or damage to product or parts caused by misuse, accident, improper operation or maintenance, or use in violation of instructions provided with the product, or to product which has been altered or modified without authorization of **AVC**, or to products or parts thereof which have had the serial number removed or changed.

Out of Warranty

In the event your product requires repair after the limited warranty period has expired, please contact our Customer Support Center at **support.rcatablets.com**

Important: You are responsible for any transportation, shipping or insurance relative to the return of product to our Product Returns Center.

All warranties implied by state law, including the implied warranties of merchantability and fitness for a particular purpose, are expressly limited to the duration of the limited warranties set forth above. With the exception of any warranties implied by state law as hereby limited,

the foregoing warranty is exclusive and in lieu of all other warranties, guarantees, agreements and similar obligations of manufacturer or seller with respect to the repair or replacement of any parts. In no event shall **AVC** be liable for consequential or incidental damages.

No person, agent, distributor, dealer or company is authorized to change, modify or extend the terms of these warranties in any manner whatsoever. The time within action must be commenced to enforce any obligation of **AVC** arising under the warranty or under any statute, or law of the United States or Canada or any state thereof, is hereby limited to one year from the date of purchase. This limitation does not apply to implied warranties arising under state law.

This warranty gives you specific legal rights and you may also have other rights, which may vary, from state to state. Some states do not allow limitation on how long an implied warranty lasts, when an action may be brought, or the exclusion or limitation of incidental or consequential damages, so the above provisions may not apply to you.

For more information on other products and services, please visit our web site at: **support.rcatablets.com**

Important: Also keep your “Bill of Sale” as proof of purchase.

FOR SUPPORT AND SERVICE, PLEASE CONTACT US
support.rcatablets.com

© 2015 AVC MULTIMEDIA